

FEHLING...

... THE DIFFERENCE

10

MICRO DISSECTION
AND RETRACTING
INSTRUMENTS

MIKRO
DISSEKTIONS- UND
HALTEINSTRUMENTE



FEHLING
INSTRUMENTS

Hanauer Landstr. 7A · 63791 Karlstein/Germany · www.fehling-instruments.de



+49 (0) 61 88 - 95 74.40



+49 (0) 61 88 - 95 74.45



info@fehling-instruments.de

CERAMO®

FI MICRO SET
FI MIKRO SET



HANDLES
HANDGRIFFE

STRAIGHT
GERADE

ABB-1

BAYONET
BAJONETT

ABB-2



STERILISATION AND STORAGE TRAY
STERILISATIONS- UND AUFBEWAHRUNGSBOX





210 x 180 mm

NUM-0

210 x 230 mm

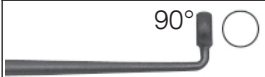
NVM-0

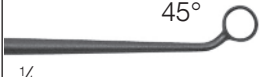







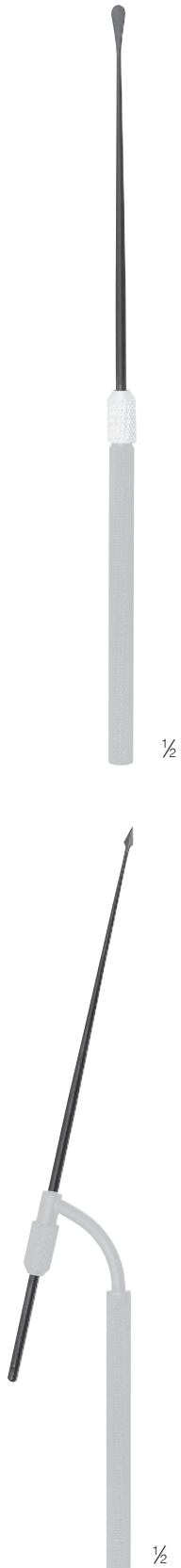

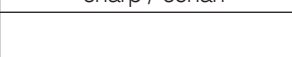

		160 mm	210 mm
 90° 1/4 ring curette / Ringkürette	2 mm	NUM-1	NVM-1
	4 mm	NUM-2	NVM-2
	6 mm	NUM-3	NVM-3
 45° 1/4 ring curette / Ringkürette	2 mm	NUM-4	NVM-4
	4 mm	NUM-5	NVM-5
	6 mm	NUM-6	NVM-6
 45° 1/4 ring curette / Ringkürette	2 mm	NUM-7	NVM-7
	4 mm	NUM-8	NVM-8
	6 mm	NUM-9	NVM-9
 40° 1/4 ring curette / Ringkürette	2 mm	NUR-1	NVR-1
	4 mm	NUR-2	NVR-2
	6 mm	NUR-3	NVR-3
 60° 1/4 ring curette / Ringkürette	2 mm	NUR-4	NVR-4
	4 mm	NUR-5	NVR-5
	6 mm	NUR-6	NVR-6

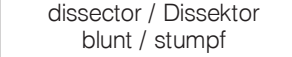
CERAMO®

FI MICRO SET
FI MIKRO SET

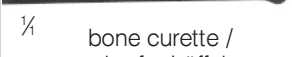
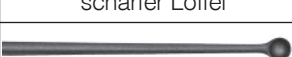

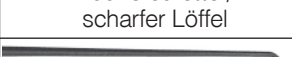





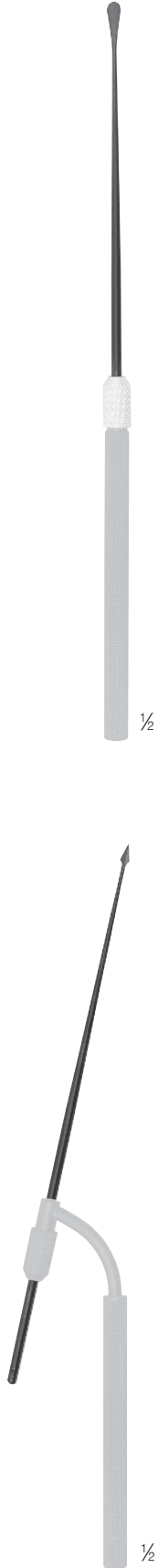

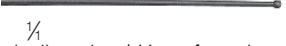

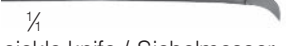



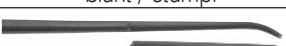
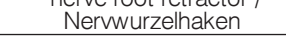

		160 mm	210 mm
	1 mm	NUN-1	NVN-1
	2 mm	NUN-2	NVN-2
	3 mm	NUN-3	NVN-3
	1 mm	NUN-4	NVN-4
	1,5 mm	NUN-9	NVN-9
	2 mm	NUN-5	NVN-5
	3 mm	NUN-6	NVN-6
	4 mm	NUN-7	NVN-7
	4 mm	NUN-8	NVN-8
	2 mm	NUO-1	NVO-1
	3 mm	NUO-2	NVO-2
	4 mm	NUO-3	NVO-3
	2 mm	NUO-4	NVO-4
	3 mm	NUO-5	NVO-5
	4 mm	NUO-6	NVO-6
	1 x 2 mm	NUT-4	NVT-4
	1 x 4 mm	NUT-5	NVT-5
	1 x 2 mm	NUP-1	NVP-1
	1 x 3 mm	NUP-2	NVP-2
	1 x 4 mm	NUP-6	NVP-6
	1 x 5 mm	NUP-4	NVP-4
	1 x 8 mm	NUP-5	NVP-5
	0,4 x 2 mm	NUP-7	NVP-7
	0,4 x 3 mm	NUP-8	NVP-8
	1 x 3 mm	NUS-0	NVS-0
	1 x 3 mm	NUP-9	NVP-9
	1 x 5 mm	NUS-1	NVS-1
	1 x 8 mm	NUS-2	NVS-2
	1 x 5 mm	NUS-3	NVS-3
	1 x 3 mm	NUS-9	NVS-9
	0,4 x 4 mm	NUT-0	-

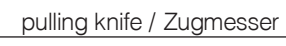
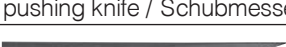
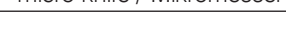
CERAMO®

FI MICRO SET
FI MIKRO SET

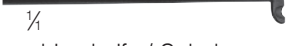

		160 mm	210 mm
	1/4 needle / Nadel	NUS-8	NVS-8
	1/4 ball probe / Knopfsonde	1 mm NUS-4	NVS-4
	1/4 lancet knife / Lanzettmesser	NUS-6	NVS-6
	1/4 sickle knife / Sichelmesser	NUS-7	NVS-7
	1/4 pulling knife / Zugmesser	3,5 mm NUP-3	NVP-3
	1/4 disc knife / Tellermesser	2 mm NUS-5	-
	1/4 disc knife / Tellermesser	4 mm NUT-1	NVT-1
	1/4 disc knife / Tellermesser	2 mm NUT-2	NVT-2
	1/4 disc knife / Tellermesser	3 mm NUR-0	-
	1/4 disc knife / Tellermesser	4 mm NUT-3	NVT-3
	1/4 micro knife / Mikromesser	NUT-6	-
	1/4 disc dissector / Tellerdissektor	2 mm NUT-7	-
	1/4 disc dissector blunt / stumpf	4 mm NUT-8	-
	1/4 LANKSCH nerve root retractor / Nerwurzelhaken	3 mm NUO-7	-
	1/4 LANKSCH nerve root retractor / Nerwurzelhaken	5 mm NUO-8	-
	1/4 tamper / Stößel	2 mm NUX-1	-
	1/4 tamper / Stößel	4 mm NUX-2	-
	1/4 tamper / Stößel	6 mm NUX-3	-
POLYTOM KNIVES* POLYTOM MESSER*		160 mm	
	1/4 pulling knife / Zugmesser	4 mm NUL-1	-
	1/4 pushing knife / Schubmesser	4,5 mm NUL-2	-
	1/4 micro knife / Mikromesser	FIGURE 11 FIGUR 11 NUT-9	-

*EXTRA HARD CARBON SURFACE















*EXTREM HARTE KOHLENSTOFFOBERFLÄCHE

CERAMO®

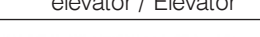
RHOTON SET

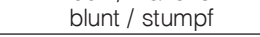

190 mm

	1 mm	NTC-1
	2 mm	NTC-2
	3 mm	NTC-3
$\frac{1}{4}$ dissector / Dissektor		
	1 mm	NTC-6
	1,5 mm	NTC-7
	2 mm	NTC-8
$\frac{1}{4}$ dissector / Dissektor		
	1,2 mm	NTC-5
	2,8 mm	NTC-4
$\frac{1}{4}$ elevator / Elevator		
	2 mm	NTC-9
$\frac{1}{4}$ hook / Häkchen semi-sharp / halbscharf		
	2 mm	NTD-1
$\frac{1}{4}$ hook / Häkchen blunt / stumpf		
	3 mm	NTD-2
$\frac{1}{4}$ hook / Häkchen semi-sharp / halbscharf		
		NTD-3
$\frac{1}{4}$ needle / Nadel semi-sharp / halbscharf		
	1 x 2 mm	NTD-4
$\frac{1}{4}$ bone curette / scharfer Löffel		
	1 x 2 mm	NTD-5
$\frac{1}{4}$ bone curette / scharfer Löffel		
	3 mm	NTD-6
$\frac{1}{4}$ nerve hook / Nervhaken		



STERILIZATION AND STORAGE TRAY
STERILISATIONS- UND AUFBEWAHRUNGSBEHÄLTER
210 x 230 x 20 mm

NBX-4



NERVE HOOK
NERVHAKEN
230 mm

$\frac{1}{4}$	3 mm	NBP-4
	5 mm	NBP-5
	8 mm	NBP-6
	14 mm	NEW-4



BONE CURETTES
SCHARFE LÖFFEL

	45° 	90° 	45°
Ø 3 mm	Ø 3 mm	Ø 3 mm	Ø 3 mm
NBC-3	NBC-4	NBC-5	NBC-6

45° 	90°
Ø 3 mm	Ø 3 mm
UP / AUF	NBD-2
DOWN / AB	NBD-3
RIGHT / RECHTS	NBD-4
LEFT / LINKS	NBD-5

ALL MODELS ALSO
AVAILABLE WITH
CERAMO SURFACE

ALLE MODELLE AUCH
MIT CERAMO-OBER-
FLÄCHE ERHÄLTlich

RING CURETTES
RINGKÜRETTEN

45° 	45° 	90° 	90°
Ø 2,5 mm	Ø 4,0 mm	Ø 2,5 mm	Ø 4,0 mm
NBB-6	NBB-7	NBB-4	NBB-5

DISSECTORS
DISSEKTOREN

SICKLE KNIFE
SICHELMESSER

2 mm	4 mm	3 x 5 mm	1/4
UP / AUF	NBA-1	NBJ-6	NAY-9
DOWN / AB	NBA-2	-	NAZ-1
RIGHT / RECHTS	-	NBK-7	NAY-7
LEFT / LINKS	-	NBL-2	NAY-8

240 mm

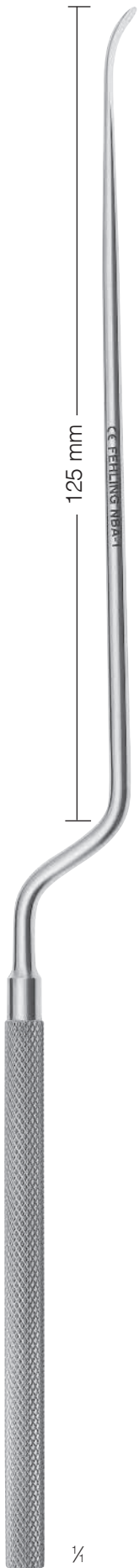

RASPATORIES
RASPATORIEN

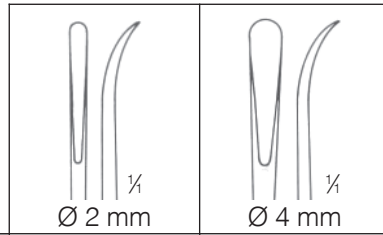

UP / AUF	NBB-8	NBC-1
DOWN / AB	NBB-9	NBC-2

NERVE HOOKS
NERVHAKEN

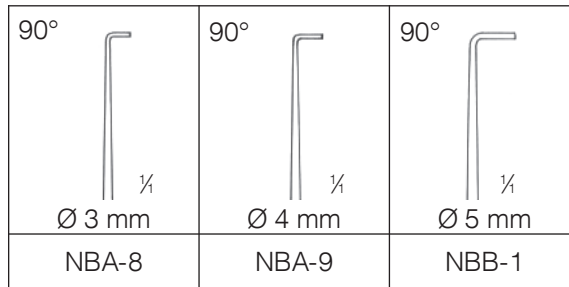

ALL MODELS ALSO
AVAILABLE WITH
CERAMO SURFACE

ALLE MODELLE AUCH
MIT CERAMO-OBER-
FLÄCHE ERHÄLTICH











	90° 2 mm semi-sharp / halbscharf	90° 2 mm blunt / stumpf	45° 3 mm blunt / stumpf	90° 3 mm blunt / stumpf	90° 3 mm ballpointed / mit Knopf
UP / AUF	NBH-8	NBH-9	NBJ-1	NBJ-5	NBJ-3
RIGHT / RECHTS	NBJ-7	NBJ-8	NBJ-9	NBK-6	NBK-4
LEFT / LINKS	NBK-1	NBK-2	NBK-3	NBL-1	NBK-8

240 mm

CERAMO®



260 mm
a = 120 mm

	0,5 mm	TOR-7
$\frac{1}{4}$ needle holder / Nadelhalter	1,0 mm	TOQ-1
	0,5 mm	TOR-8
$\frac{1}{4}$ needle holder / Nadelhalter	1,0 mm	TOQ-2
	2,0 mm	TOQ-3
$\frac{1}{4}$ spoon pliers / Löffelzange	4,0 mm	TOQ-4
	2,0 mm	TOQ-5
$\frac{1}{4}$ spoon pliers / Löffelzange		
	pointed spitz	TOR-1
$\frac{1}{4}$ scissors / Schere	blunt stumpf	TOR-3
	pointed spitz	TOR-2
$\frac{1}{4}$ scissors / Schere	blunt stumpf	TOR-4
	blunt stumpf	TOR-9
$\frac{1}{4}$ scissors / Schere	pointed spitz	TOR-0
	blunt stumpf	TOQ-0
$\frac{1}{4}$ scissors / Schere		
	0,5 mm	TOR-5
$\frac{1}{4}$ forceps / Pinzette		
	0,5 mm	TOR-6
$\frac{1}{4}$ forceps / Pinzette		

ROTATABLE SHAFT
DREHBARER SCHAFT





FOR / FÜR YASARGIL CLIPS

		CLIP ROTATABLE / DREHBAR	
		 1/4	
TOTAL LENGTH GESAMTLÄNGE		230 mm	270 mm
LENGTH a LÄNGE a		80 mm	120 mm
CLIP SIZE CLIP GRÖÖE	MINI	TOQ-9	TOQ-7
	STANDARD	TOQ-8	TOQ-6

ROTATABLE SHAFT
DREHBARER SCHAFT



FOR / FÜR YASARGIL CLIPS

		CLIP FIXED / STARR			CLIP ROTATABLE / DREHBAR		
		 1/4			 1/4		
LENGTH a LÄNGE a		70 mm	90 mm	110 mm	70 mm	90 mm	110 mm
CLIP SIZE CLIP GRÖÖE	MINI	NIB-1	NIB-2	NIB-3	NIB-7	NIB-8	NIB-9
	STANDARD	NIC-0	NIC-1	NIB-0	NIB-4	NIB-5	NIB-6

MALLEABLE SHAFT / BIEGBARER SCHAFT

The shafts of MEMORY clip applying forceps are constructed of shape-memory metal. They are malleable in normal O.R. temperatures. Soft pressure allows "permanent" deformation of shape according to the surgeon's needs. However in higher temperatures, such as those found in the autoclave, the instruments regain their initial shape.

MEMORY Clipanlegezangen haben einen Schaft aus Formgedächtnismetall. Sie sind bei normaler OP-Temperatur biegsam. Sie können durch sanften Druck in die gewünschte Form gebracht werden. Unter höheren Temperaturen, wie bei der Sterilisation, nehmen sie ihre ursprüngliche Form wieder an.

CERAMO® NICOLA



SCISSORS
SCHEREN

	straight / gerade	up / aufwärts	down / abwärts	left / links	right / rechts
160 mm	NOJ-1	NOJ-2	NOJ-3	NOJ-4	NOJ-5
	NBR-9	-	-	-	-
200 mm	NTF-1	NTF-4	NTF-5	NTF-3	NTF-2
	TOM-6	-	-	TOM-8	TOM-7
	NBS-1	NBS-2	NBS-3	NBS-5	NBS-4
250 mm	NOL-7			NOL-8	NOL-9

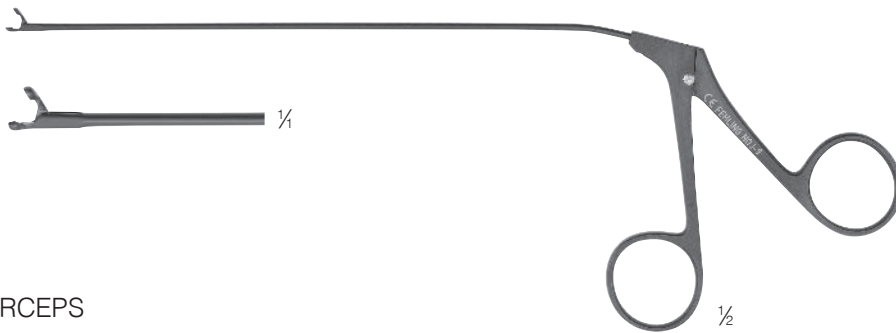

GRASPING FORCEPS
FASSZANGEN

	straight / gerade	up / aufwärts	down / abwärts	left / links	right / rechts
160 mm	NOJ-6	NOJ-7	NOJ-8	NOJ-9	NOK-0
	NBR-3	-	-	-	-
180 mm	-	-	-	NOM-0	NOI-9
200 mm	NTF-6	NTF-7	NTF-8	NTF-9	NTG-0
	TOM-1	-	-	-	-
	NBR-4	NBR-5	NBR-6	NBR-8	NBR-7
250 mm	NOK-8	-	-	-	-

TITANIUM / TITAN

UNCOATED / UNBESCHICHTET

CERAMO®



LOWER BLADE SERRATED
UNTERES BLATT GEZAHNT

STRONG SCISSORS
STARKE SCHERE
180 mm
NIC-5

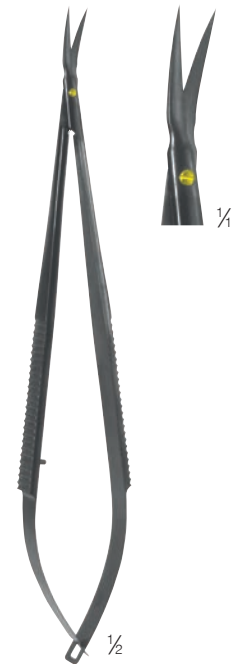

NC MICRO SCISSORS
NC MIKROSCHERE
160 mm
BBO-1B

12 mm



TITANIUM
SPATULA
SPATEL
200 mm

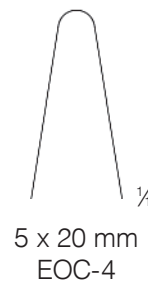
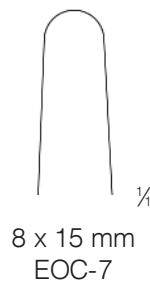
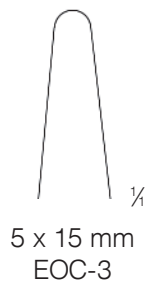
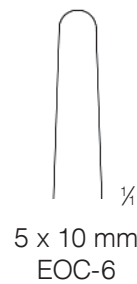
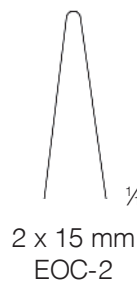
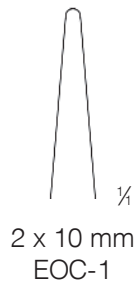

MALLEABLE / BIEGBAR

CERAMO® SUPERPLAST

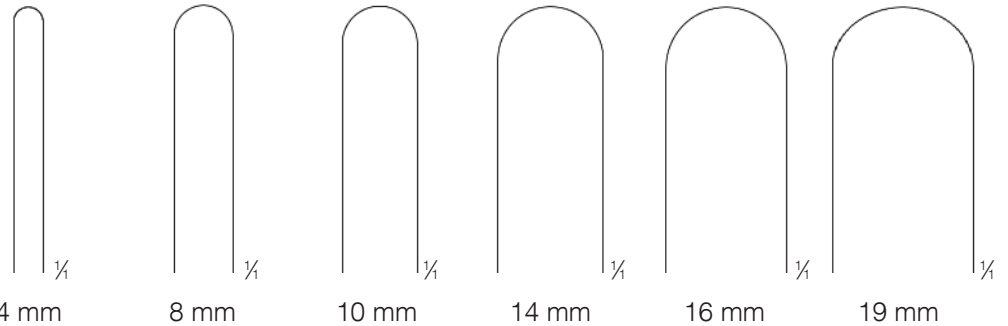

STANDARD	EOI-1	EOI-2	EOI-3	EOI-4	EOI-5	EOI-9
STRONG STARK	EOI-6	EOI-7	EOI-8	EOK-9	-	-

SUPERPLAST Instruments are constructed of shapememory metal. They are malleable in normal O.R. temperatures. Soft pressure allows "permanent" deformation of shape according to the surgeon's needs. However in higher temperatures, such as those found in the autoclave, the instruments regain their initial shape.

SUPERPLAST Instrumente sind aus Metall mit Formgedächtnis. Sie sind bei normaler OP-Temperatur biegsam. Sie können durch sanften Druck in die gewünschte Form gebracht werden. Unter höheren Temperaturen, wie bei der Sterilisation, nehmen sie ihre ursprüngliche Form wieder an.

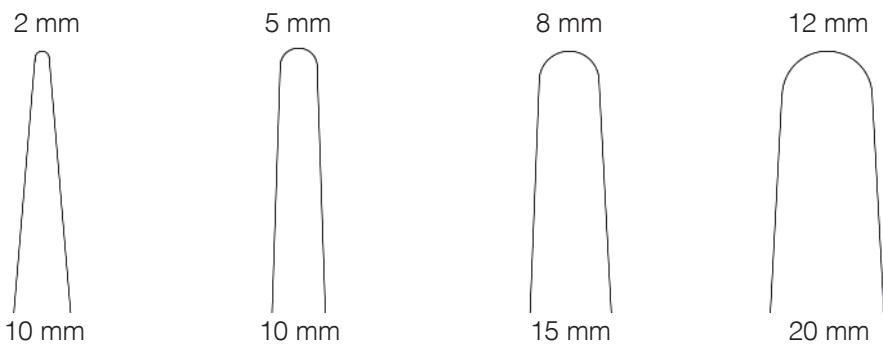

STANDARD	EOK-1	EOK-2	EOK-3	EOK-4
STRONG STARK	EOK-5	EOK-8	EOK-7	-

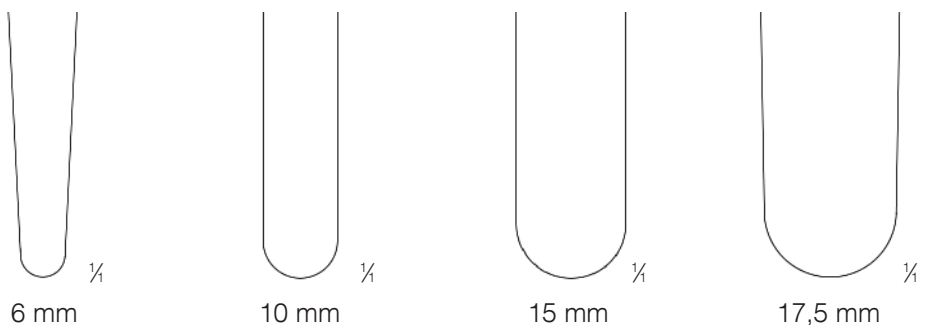

CERAMO® SUPERPLAST

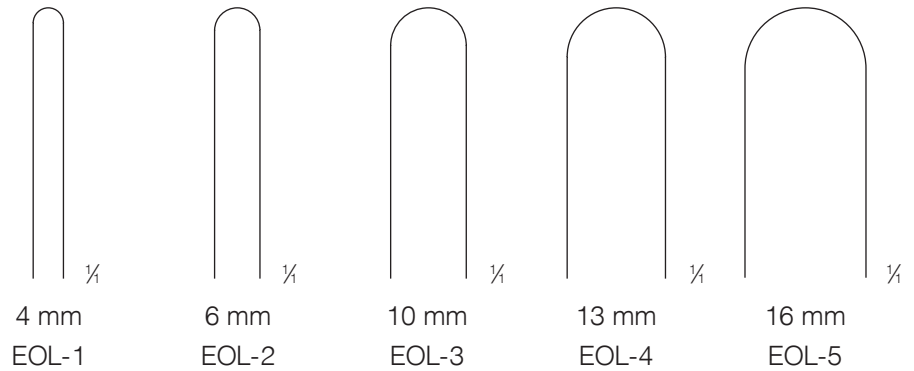

SUPERPLAST Instruments are constructed of shapememory metal. They are malleable in normal O.R. temperatures. Soft pressure allows "permanent" deformation of shape according to the surgeon's needs. However in higher temperatures, such as those found in the autoclave, the instruments regain their initial shape.

SUPERPLAST Instrumente sind aus Metall mit Formgedächtnis. Sie sind bei normaler OP-Temperatur biegsam. Sie können durch sanften Druck in die gewünschte Form gebracht werden. Unter höheren Temperaturen, wie bei der Sterilisation, nehmen sie ihre ursprüngliche Form wieder an.

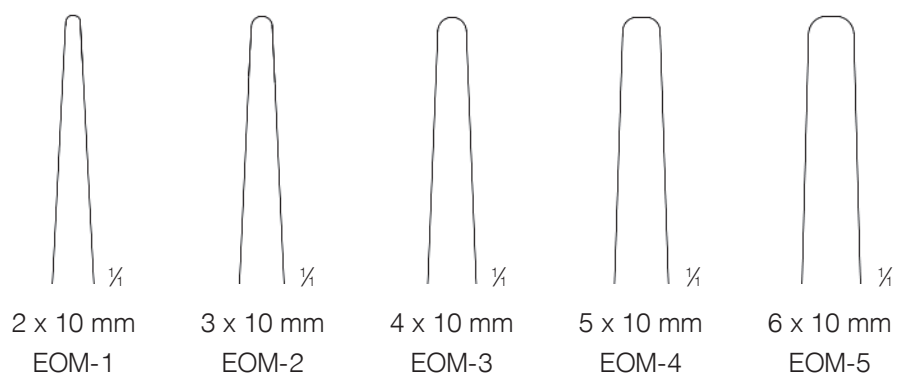

Shafts suitable for all common head rest systems.
Die Schäfte passen in alle gängigen Kopfhaltssysteme.

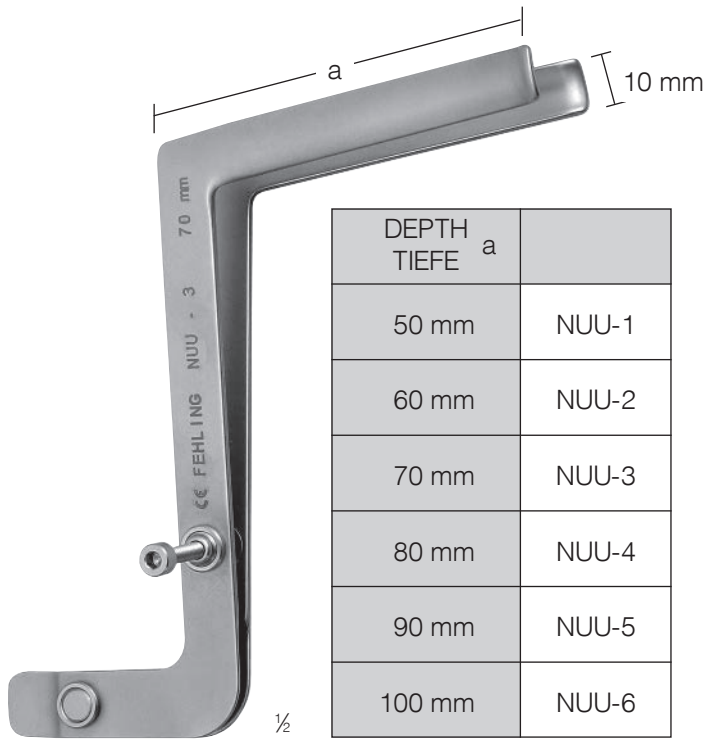

DEPTH TIEFE	a
50 mm	NUU-1
60 mm	NUU-2
70 mm	NUU-3
80 mm	NUU-4
90 mm	NUU-5
100 mm	NUU-6

PERNECZKY TITANIUM
MICRO RETRACTOR
MIKROSPREIZER



SUPPORT FOR LEYLA-RETRACTOR
SPATELHALTER FÜR LEYLA-RETRAKTOR

NEA-2



exemplary configuration
Konfigurationsbeispiel

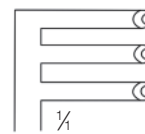

3 x 3 TEETH/ZÄHNE
SEMI-SHARP
HALBSCHARF

DIETZ
160 mm
ECP-5H

CONCEPT

CEREBELLAR RETRACTOR
CEREBELLUM SPREIZER



exemplary configuration
Konfigurationsbeispiel



BODY
RAHMEN
190 mm
NDN-4

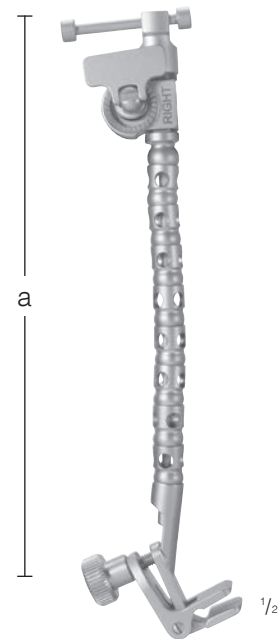

FLEXIBLE ARM WITH SPATULA ADAPTER
SPANNARM MIT SPATELHALTER

SEGMENTS GLIEDER	LENGTH LÄNGE ^a	
7	135 mm	NDO-1
8	145 mm	NDN-6
11	175 mm	NDN-9
15	215 mm	NDO-0

FIND SPATULAS ON PAGE 12 + 13
PASSENDE SPATEL AUF SEITE 12 + 13



CERAMO®
TRANSNASAL SPECULUM
TRANSNASALES SPECULUM

70 x 12 mm	NVG-1V
	NVL-1V
80 x 12 mm	NVG-2V
	NVL-2V
90 x 12 mm	NVG-3V
	NVL-3V
100 x 12 mm	NVG-4V
	NVL-4V
110 x 12 mm	NVG-5V
	NVL-5V

TITANIUM / TITAN



CERAMO®
HEXAGON WRENCH
FOR SPECULUM
SECHSKANTSCHLÜSSEL
FÜR SPEKULUM

NVG-9



KILLIAN
NASAL SPECULUM
NASENSPEKULUM

with locking screw
mit Stellschraube



KILLIAN
NASAL SPECULUM
NASENSPEKULUM

37 x 7 mm	OAT-9
52 x 7 mm	OAU-1
75 x 7 mm	OAU-2

36 x 7 mm	OAT-5
56 x 7 mm	OAT-6
75 x 7 mm	OAT-7
90 x 7 mm	OAT-8